

2024

联合资信评估股份有限公司
China Lianhe Credit Rating Co.,Ltd.

专业 | 尽责 | 真诚 | 服务

信用评级公告

2024 7513

" 22 01" " 21 AAA " 23 01"
" 21 " " AAA
" 21 " AA+

Add: 17/F, PICC Building, 2, Jianguomenwai Street, Beijing PRC:100022

地址: 北京市朝阳区建国门外大街2号PICC大厦17层 邮编:100022

电话 (Tel): (010) 85679696 | 传真(Fax):(010)85679228 | 邮箱 (Email):lianhe@lhratings.com



2024

23	01/22 21	01/21	AAA/ AAA/ AA+/ "	AAA/ AAA/ AA+/ " A+H"	2024/07/30
----	-------------	-------	---------------------------	--------------------------------	------------

2023

1

3

- " A+H"
-
-

- 2023

-
- 2023



2023



V4.0.202208

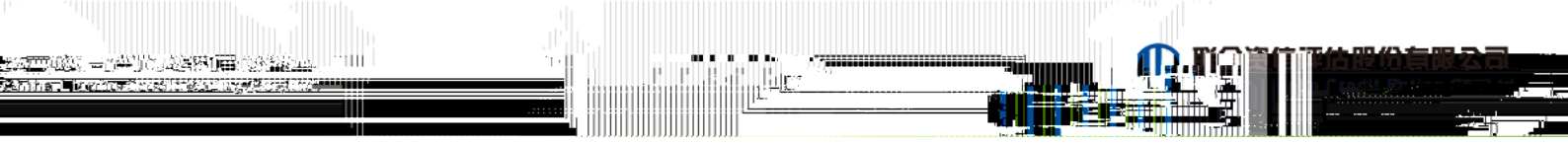

23	01	50.00	3.02%	2026-03-13	--
22	01	50.00	2.95%	2025-12-01	--
21		50.00	3.16%	2024-08-23	--
21		100.00	4.80%	--	5

23	01					V4.0.202208	
22	01	AAA/	AAA/	2023/07/28		V4.0.202208	
21						V4.0.202208	
21		AA+/	AAA/	2023/07/28		V4.0.202208	
23	01	AAA/	AAA/	2023/02/28		V4.0.202208	
22	01	AAA/	AAA/	2022/11/17		V4.0.202208	
21		AA+/	AAA/	2021/09/26		V3.1.202011	
21		AAA/	AAA/	2021/08/06		V3.1.202011	

wangning@lhratings.com

zhangxu@lhratings.com

lianhe@lhratings.com	www.lhratings.com	
010-85679696	010-85679228	
2	17 100022	

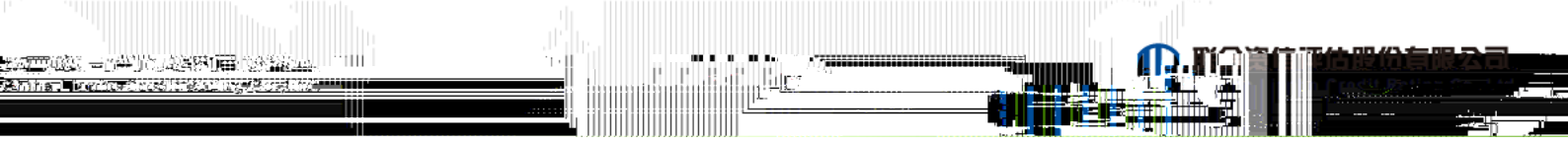

" " " "

1996 11 48 2015 12 2018

12.00 H 2016 1 H 1.80

9 " 002936" (A 6.00 27.09

2023 6 10 1 8.27 2023

82.66 90.92 A H 77.78% 22.22% 1

1 • 2023

1		22.22%
2		7.23%
3		6.69%
4		4.24%
5		3.84%

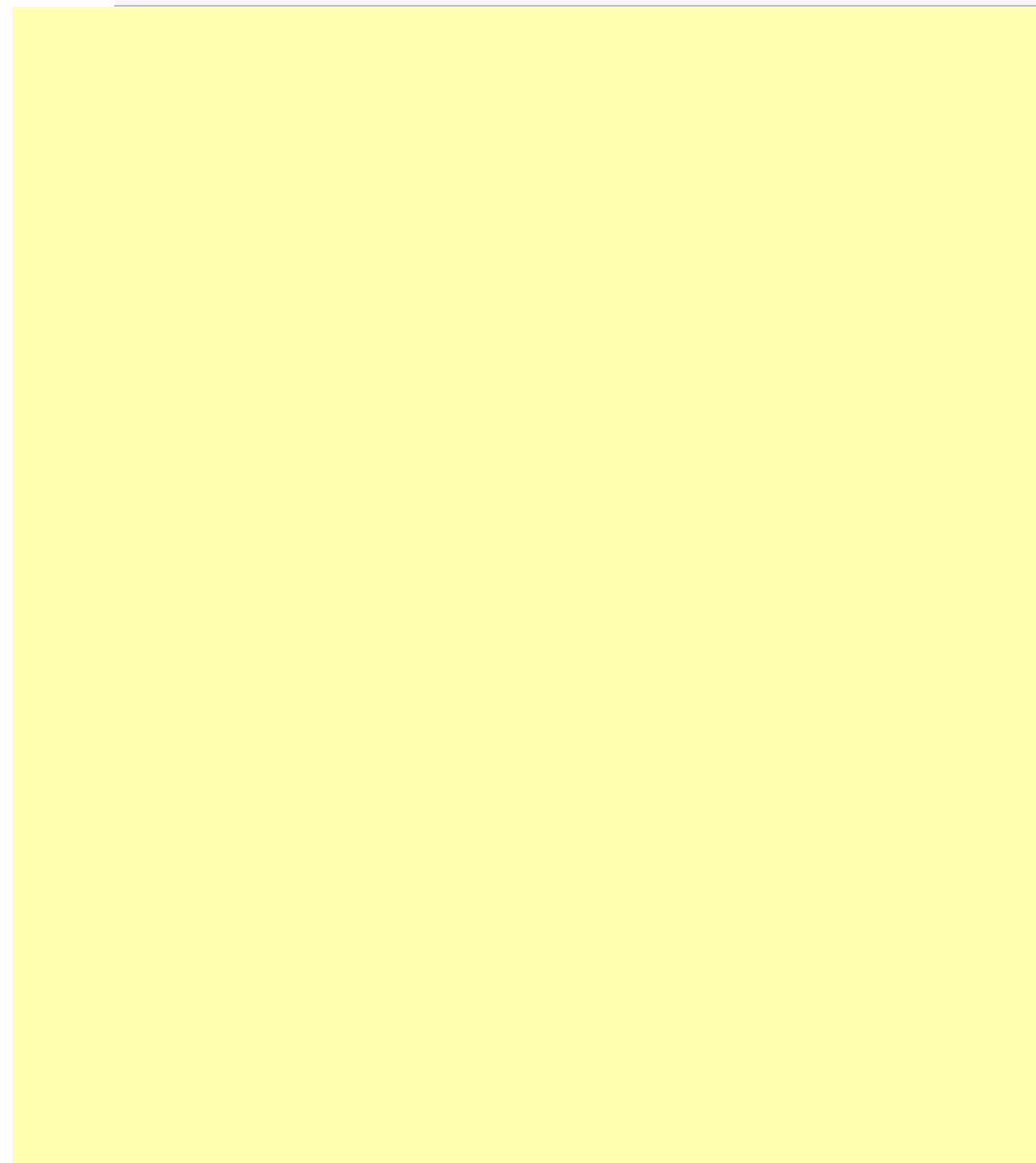

组

2024

2024
5%

GDP

5.3%

5.2%

GDP

2024



2023

2023

2023

354.85

10.96%

2023

2023

1.59% 2.20%
1.69%

0.04 0.05

205.14%

2023

2024

2024



2023

2023

59132.39

4.1%

5360.15

1.8%

22175.27

4.7%

31596.98

4.0% 2023

6972.49

12.9%

17892.8

6259.7

,

11633.1

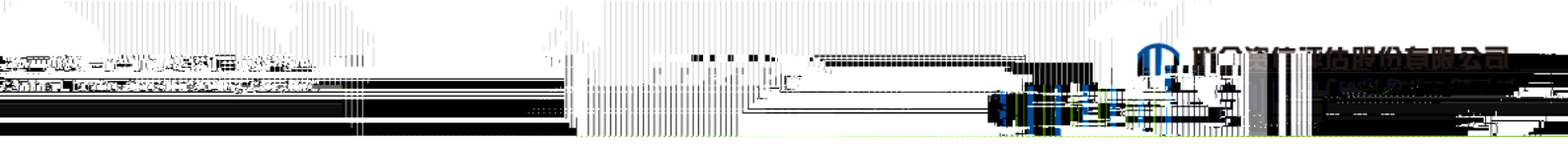

" "

		2023		13617.8		7.4%	
172.2		1.0%	5373.4		11.1%	8072.2	5.1%
1.3	39.4	59.3	2023	1827.4		19.6%	1165.8
3.1%				1519.6	4.3%	3355.3	1490.3
	1865				12.8%		1.7%
	6.8%				5.8%		2023
	30458.7		4.9%		36842.3		6.4%

七

2023 3

4

7

7

2023

13.92%

19.94%

2023

10.38%

2023

9.32%

3.97%

16.41%

27.69

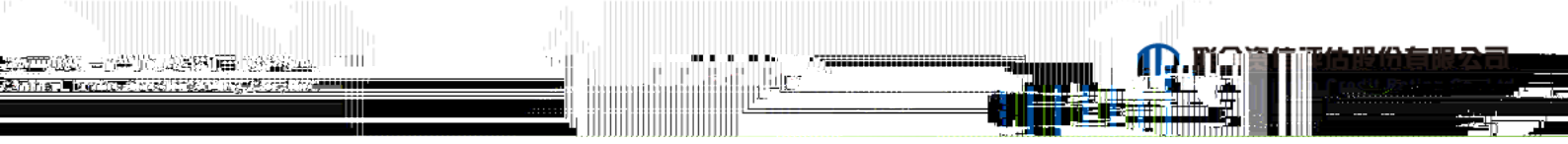

AA+

AA

2023

2023

54.25

10.29%

10.64

6.86%

2.01

7•

	922.72	1018.82	1181.86	45.90	54.97	62.49
	481.83	569.61	657.44	23.97	30.73	34.76
	378.48	348.21	349.08	18.83	18.79	18.46
	18.88	55.37	82.47	0.94	2.99	4.36
	43.54	45.64	92.86	2.17	2.46	4.91
	1.74	--	--	0.09	--	--
	111.48	143.66	128.65	5.55	7.75	6.80
	805.99	596.14	555.43	40.10	32.17	29.37
	9.75	12.62	12.79	0.49	0.68	0.68
	0.60	--	--	0.03	--	--
	157.90	82.08	12.48	7.86	4.43	0.66
	18.7	22.89	18.95	--	--	--
	45.56	40.77	40.59	--	--	--
				--	--	--

2023

2023

5



8•

	334.33	264.87	263.70	5.81	4.48	4.18	-20.77	-0.44
	213.30	167.19	181.61	3.71	2.83	2.88	-21.62	8.62
	2823.99	3222.07	3503.25	49.11	54.47	55.54	14.10	8.73
	1983.31	1835.45	1869.58	34.49	31.03	29.64	-7.46	1.86
	394.87	425.55	488.96	6.87	7.19	7.75	7.77	14.90

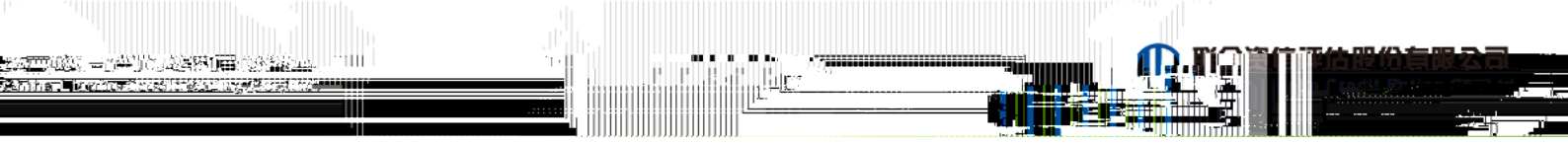

2023 2023 181.61
 62.28 12.44 106.89 371.9
 0.70 0.07

2023 2023 1869.58
 21.78% 65.66% 12.23%

2023 14.39
 2023 37.10
 136.18 40.59

2023 801.52 597.93
 48.95% 77.48 89.42 8.85 27.83



10 •

	1677.52	1731.81	1747.55	32.54	32.14	30.32	3.24	0.91
	3215.74	3417.98	3665.22	62.37	63.43	63.59	6.29	7.23
	1216.80	1410.63	1686.43	23.60	26.18	29.26	15.93	19.55
	262.42	239.09	351.18	5.09	4.44	6.09	-8.89	46.88

2023 2023
 1747.55 30.32% 143.08 332.47
 251.32 1020.69 179.98 14
 838.55

60% 2023
 2023 64.28% 67.40%

2023
 2023

11 •

%	63.72	72.34	59.10
%	339.61	300.13	265.83
%	114.84	120.68	109.01
%	90.66	97.99	99.90

■ 组 七

12 •

	148.01	151.01	136.67
	119.49	122.54	117.40
	12.42	7.91	5.79
			10.64
		-2.74	

2023



2023 543.15 90.92 2023 99.99 59.85 2023 36.90

153.05 82.67

2023

2 2023 23.56

13 •

		399.49	403.83
		579.31	505.66
		631.67	552.92
		4210.14	4347.70
	%	73.22	73.50
	/ %	10.33	8.90
	%	15.00	12.72
	%	13.76	11.63
	%	9.49	9.29

2023

13617.8

1827.4

" "

200.00

100.00

2023

14

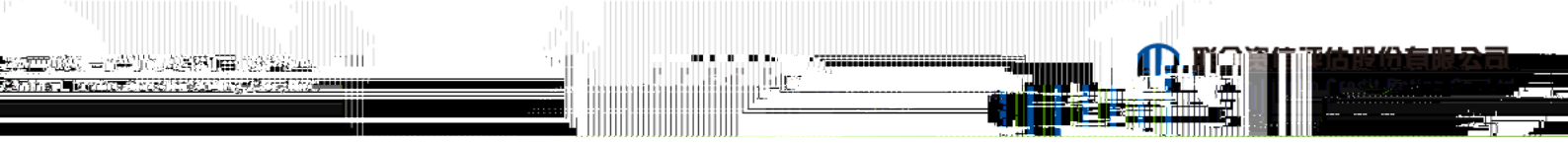

1

2023

		22.22%
		7.23%
		6.69%
		4.24%
		3.84%
		3.63%
		3.50%
		1.76%
		1.48%
		1.46%

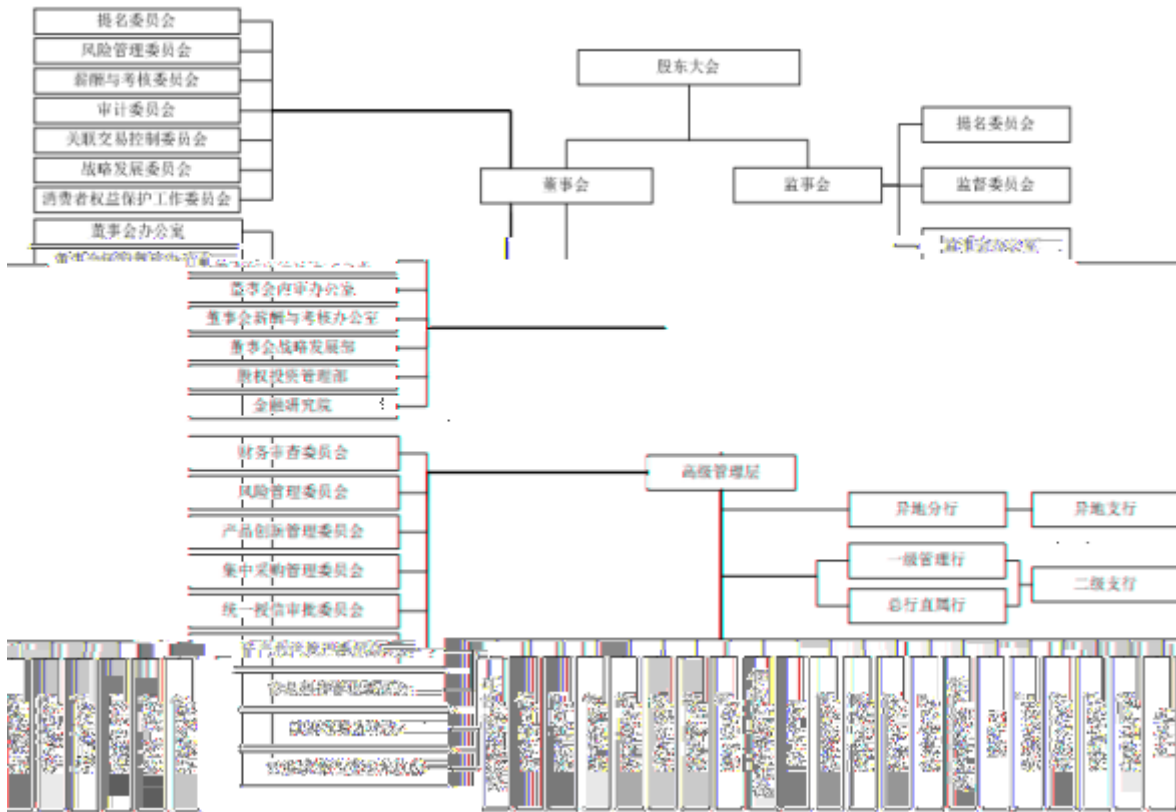

	+							
			+	+				
			+	+		+	+	
		+		+	+		+	+
	+							
			/		×100%			
			/		×100%			
		/		×100%				
		/		×100%				
		/		×100%				

4-1

AAA AA A BBB BB B CCC CC C AAA CCC

" + " - "

AAA	
AA	
A	
BBB	
BB	
B	
CCC	
CC	
C	

4-2

4-3